

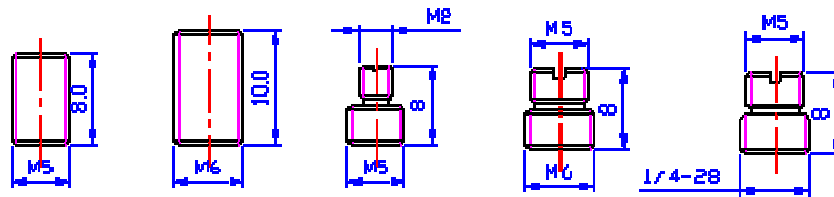

Mounting Stud

Mounting Stud Thread: M5-M5, M6-M6, M3-M5, M5-M6, M5-1/4x28 (English)



Stud Thread	M5-M5	M5-M6	M3-M5	M5-M6	M5-1/4x28
Mounting Toque (N-cm)	150 ~ 200	600 ~ 800	90 ~ 130	150 ~ 200	150 ~ 200

1. Adhesive Mounting Base

a) General adhesive Mounting Base

Diameter Size: Φ 14mm, Φ 16mm, Φ 18mm

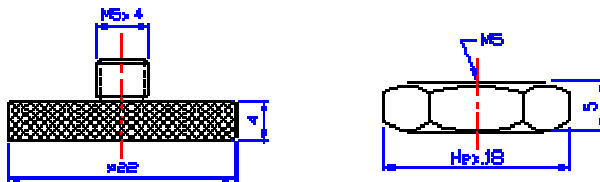

b) Electric Isolated Mounting base

i. M5 External Thread Electric Isolated Mounting base

Hex Size: 14 mm, 16 mm, 18mm

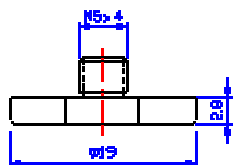

ii. M5 Female Thread Electric Isolated Mounting base

Hex Size: 16 mm, 18 mm

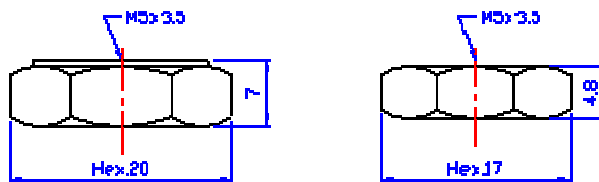

2. Thread Mounting Electric Isolated Mounting Base

a) M5 External Thread / M5 Female Thread Electric Isolated Mounting base

Hex Size: 16 mm, 18 mm, 20 mm

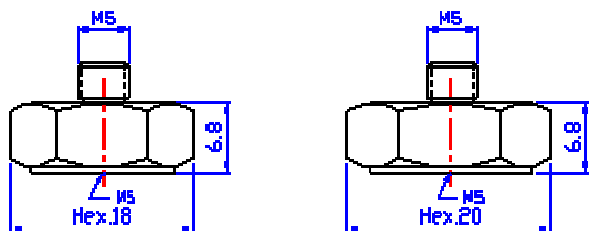

b) M5 Female Thread / M5 Female Thread Electric Isolated Mounting base
Hex Size: 16 mm, 18 mm, 20 mm

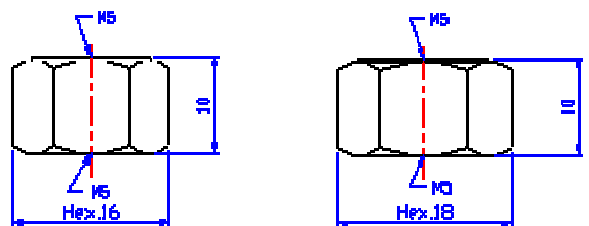

3. Tri- axis Mounting Base

a) General Stainless-steel Mounting Base

Block Size: 10x10x10(mm), 15x15x15(mm), 20x20x20(mm)

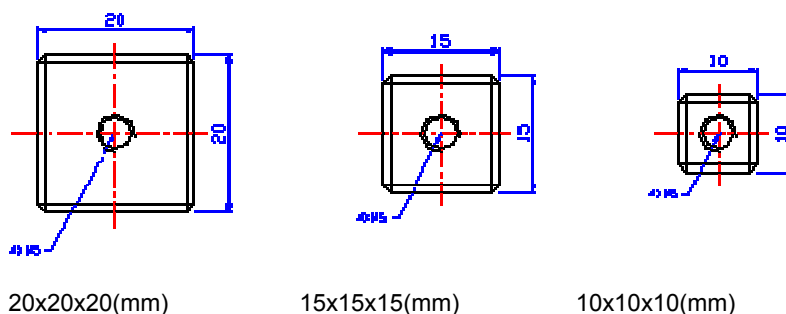

b) Electric Isolated Mounting base

Block Size: 15x15x15(mm), 20x20x20(mm)

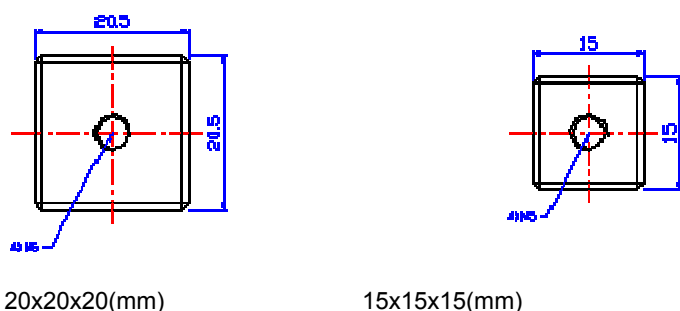

4. Magnetic Mounting Base

a) General Magnetic Stainless-Steel Mounting Base with M5 External Thread

Out-side Diameter: Φ 20mm, Φ 25mm

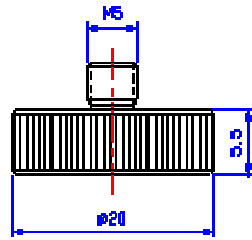

Φ20 (mm)

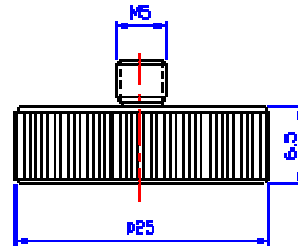

Φ25 (mm),

b) Electric Isolated Magnetic Stainless-Steel Mounting Base with M5 External Thread

Out-side Diameter: Φ20mm

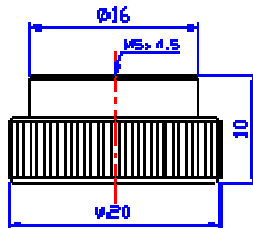

Φ20mm

Cable

The sizes and general specification are listed in the table below.

Description	Capacitance (pF/m)	External Jacket Material	Operating Temperature	Signal Types	Typical Cable Connector
Φ2 mm General Low Noise	105	PVC	90	Charge/Voltage	M5, M6, BNC
Φ3 mm General Low Noise	95	PVC	90	Charge/Voltage	M5, M6, BNC, TNC
Φ1.6 mm High Temp. Low Noise	105	Teflon 46	150	Charge/Voltage	M5, BNC
Φ2 mm High Temp. Low Noise	105	Teflon 46	150	Charge/Voltage	M5, M6, BNC
Φ3.5 mm High Temp. Twisted two wires	80	Teflon 46	150	Voltage	M12, M16, Integral Cable
Φ3.5 mm High Temp. Twisted two wires	80	Teflon 46	150	Voltage	¼-28 4 Pin Connector
Φ4.5 mm Twisted two wires w/Shield	65	PVC	90	Voltage	M12, M16, Integral Cable
Φ5 mm General Co-axial	105	PVC	90	Voltage	BNC, TNC
Φ6 mm Twisted four wires w/Shield	80	PVC	90	Voltage	M12, Integral Cable

Connector and Connector Converter

Cable Connectors: M5, M6, BNC, TNC, BNC-50KY, M12, M16, ¼-28 4 Pin Connector

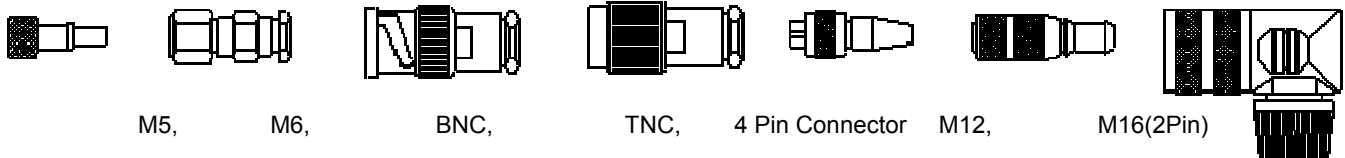

M5, M6, BNC, TNC, 4 Pin Connector, M12, M16(2Pin)



Connector Converte

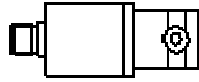
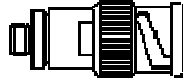

M5◇M5
C50KY

M5◇BNC

M5◇BNC-50KY

BNC◇BNC

BNC-50KY◇BN

Note:The thread difference between M5 and English 10-32